

- AS ADJUSTABLE SHELF
- COH COAT HOOK
- COM/2 COMMUNICATION OUTLET - DOUBLE
- DA DURESS ALARM
- DDG DISPENSER - DISPOSABLE GLOVES
- DHT DISPENSER - HAND TOWEL
- DP DOOR AND DOOR FRAME PROTECTION
- DS DISPENSER - SOAP
- DSA DISPENSER - SOAP ANTISEPTIC
- EC EMERGENCY CALL
- GPO/1 GENERAL POWER OUTLET - SINGLE
- GPO/2 GENERAL POWER OUTLET - SINGLE
- GPO/C GENERAL POWER OUTLET - CLEANER'S
- LS/R LIGHT SWITCH - ROOM
- LS/P LIGHT SWITCH - PELMET TASK LIGHT
- NA NURSE ASSIST
- NC CALL PATIENT/ NURSE CALL
- SK4 FLOOR VINYL COVERED
- V1 FLOOR VINYL STANDARD SLIP RESISTANT
- XRV/2 XRAY VIEWER, 2 SCREENS

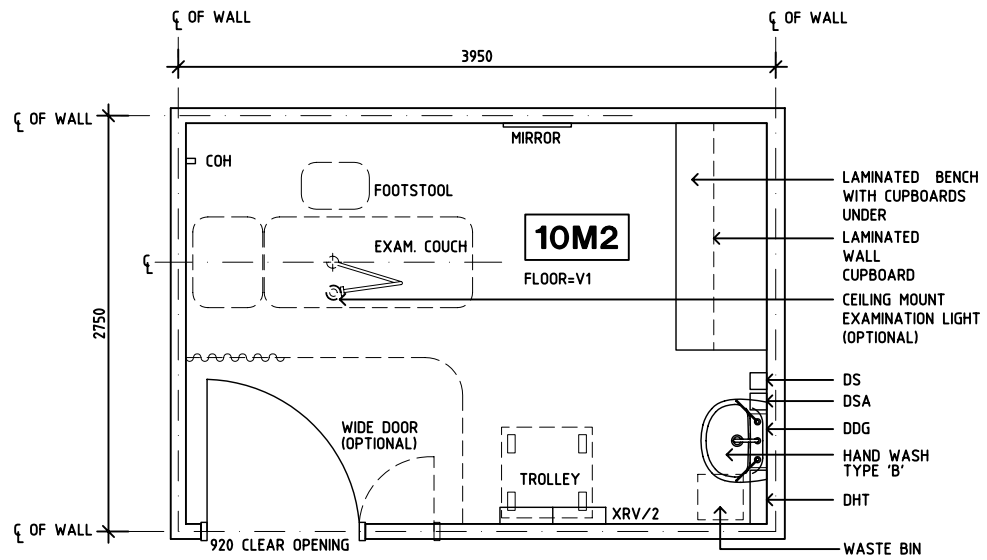

PLAN

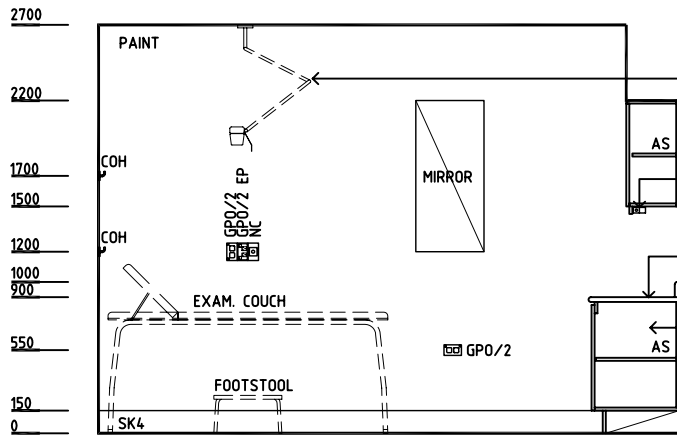

ELEVATION 1

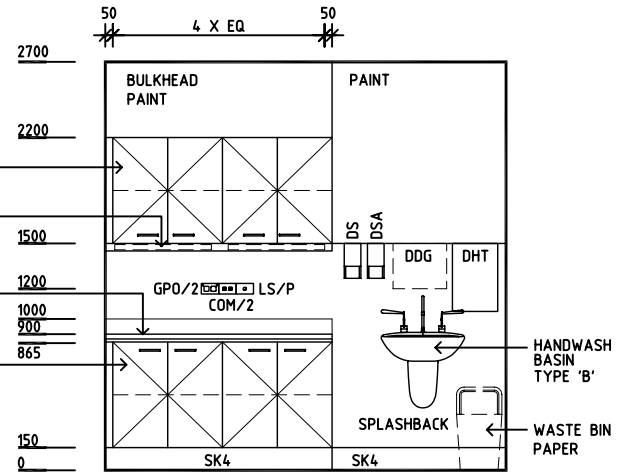

ELEVATION 2

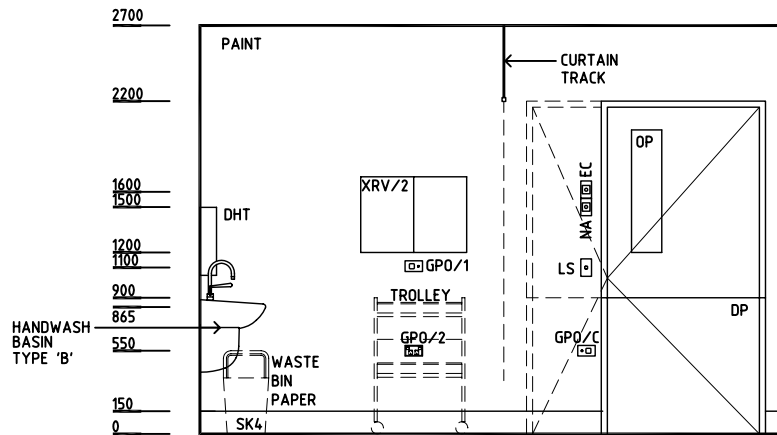

ELEVATION 3

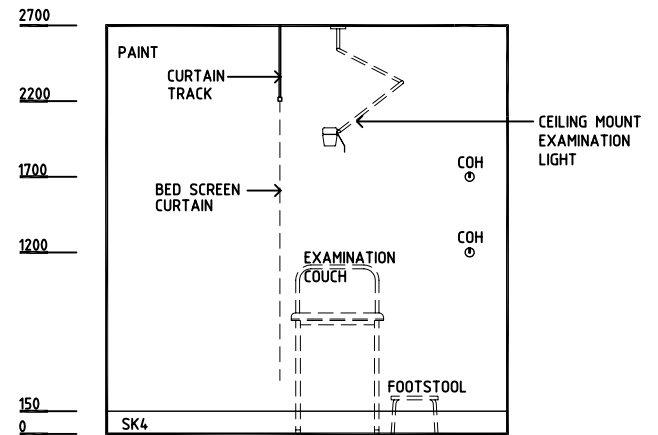

ELEVATION 4

REV	DESCRIPTION	DATE	BY	REV	DESCRIPTION	DATE	BY	REV	DESCRIPTION	DATE	BY
1	FIRST ISSUE	24.10.10	LL								
2	GENERAL REVISION	30.08.11	ASD								
3	GENERAL REVISION	31.10.12	KC								

iHFG Standard Components

Room Layout Sheet

Room Name

Mould Room - Fitting

RLS Room Code MLD-FT-I

RDS Room Code MLD-FT-I

GENERAL NOTES:

THIS DRAWING TO BE READ IN CONJUNCTION WITH R.D.S. (ROOM DATA SHEETS) WHICH TAKES PRECEDENCE.

ALL SERVICES INDICATED ARE INDICATIVE AND SUBJECTED TO DETAILED PROJECT SPECIFIC ENGINEERING DESIGN.



CEILING LEGEND:

ACT ACOUSTIC CEILING TILES
 PBB PLASTERBOARD BULKHEAD, PAINT
 PC4 24mm. SHADOW ANGLE, POWDERCOAT ALUMINIUM CORNICE



--- GRID LINE
 TILE CEILING GRID (1200 x 600)

 CEILING TYPE
 HEIGHT ABOVE F.F.L.



ELECTRICAL LEGEND:

 FLUORESCENT DOWNLIGHT - COMPACT, COLOUR CORRECTED - CYANOSIS
 DECORATIVE DOWNLIGHT - RECESSED, DIMMABLE

MECHANICAL LEGEND:

 SUPPLY AIR GRILLE
 RETURN AIR OR TRANSFER GRILLE

FIRE SERVICES LEGEND:

 SMOKE DETECTOR
 SPRINKLER

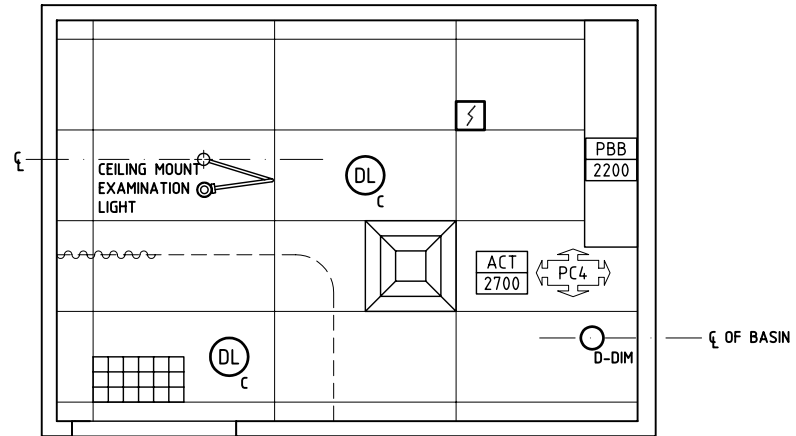

REFLECTED CEILING PLAN

REV	DESCRIPTION	DATE	BY	REV	DESCRIPTION	DATE	BY	REV	DESCRIPTION	DATE	BY
2	GENERAL REVISION	30.08.11	ASD								
3	GENERAL REVISION	31.10.12	KC								

 International Health Facility Guidelines	International Health Facility Guidelines at: www.healthdesign.com.au/iHFG Editable version of Standard Components on Health Facility Briefing System (HFBS) at: www.healthdesign.com.au ©TAHPI				DESIGNED	APPROVED	DATE	SCALE(S)	SHEET
	CC	AA/DB	24.10.10	1:50 in A3	2 of 2				
	CAD FILE NAME		PAPER DRAWING ID		ISSUE				
MLD-FT-I		MLD-FT-Ib		3					



The International Health Facility Guidelines recommends the use of HFBS “Health Facility Briefing System” to edit all room data sheet information for your project.

HFBS provides edit access to all iHFG standard rooms, and departments, and more than 100 custom report templates.

HFBS Health Facility Briefing System



Briefing Module

The Health Facility Briefing System (HFBS) has numerous modules available via annual subscription. It suits healthcare Architects, Medical Planners, Equipment Planners Project Managers and Health Authorities.

Use the HFBS Briefing Module to quickly drag in health facility departments or pre-configured room templates from the iHFG standard, edit the room features such as finishes, furniture, fittings, fixtures, medical equipment, engineering services. The system can print or download as PDF more than 100 custom reports including room data sheets, schedules, and more...

To learn more about the HFBS web-based Healthcare Briefing and Design Software and to obtain editable versions of the “Standard Components” including Room Data Sheets (RDS) and Room Layout Sheets (RLS) offered on the iHFG website, signup for HFBS using the link below.

Get Started Now:
hfbs.healthdesign.com.au

- ✓ iHFG Room Data Sheets and Departments are instantly editable in the HFBS software available online.
- ✓ You can access hundreds of report templates to print your iHFG room data in HFBS.
- ✓ HFBS has a onetime free 3 day trial available to all new users.

Get Started Now:
hfbs.healthdesign.com.au



HFBS

Health Facility Briefing System

hfbsinfo.com | techsupport@healthdesign.com.au