

iHFG Standard Components

Room Layout Sheet

Room Name **Blood Collection Work Area**

RLS Room Code **BLDCW-I**

RDS Room Code **BLDCW-I**

- AS ADJUSTABLE SHELVES
- CG CORNER PROTECTION
- COM/2 COMMUNICATION OUTLET-DOUBLE
- DHT DISPENSER - HAND TOWEL
- DS DISPENSER - SOAP
- DSA DISPENSER - SOAP ANTISEPTIC
- GPO/1 GENERAL POWER OUTLET - SINGLE
- LS/P LIGHT SWITCH - PELMET TASK LIGHT
- SK4 FLOOR VINYL COVERED SKIRTING
- V1 VINYL FLOORING, STANDARD SLIP RESISTANT

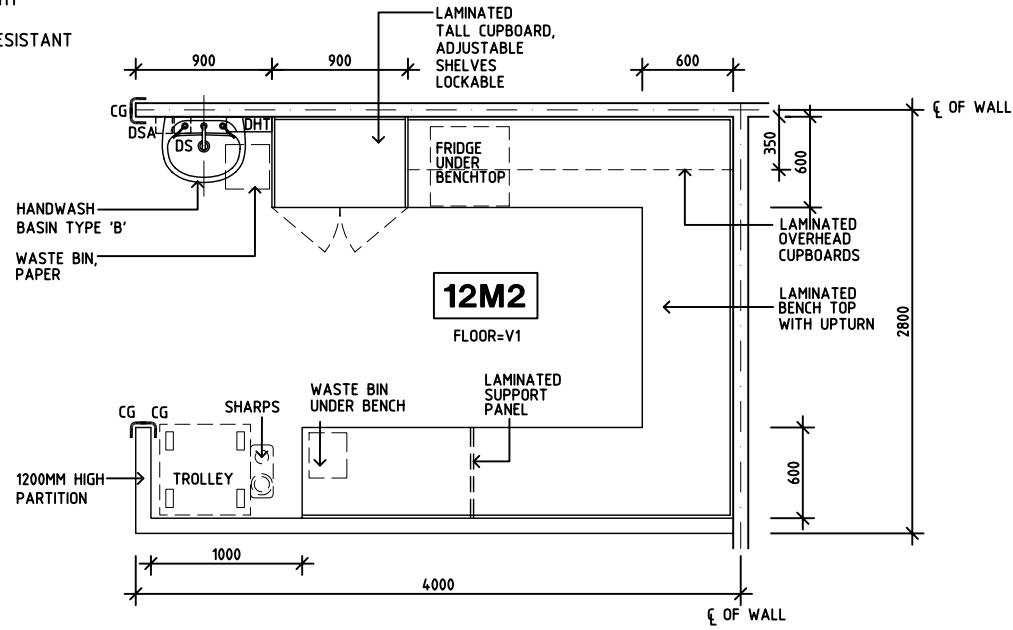

PLAN

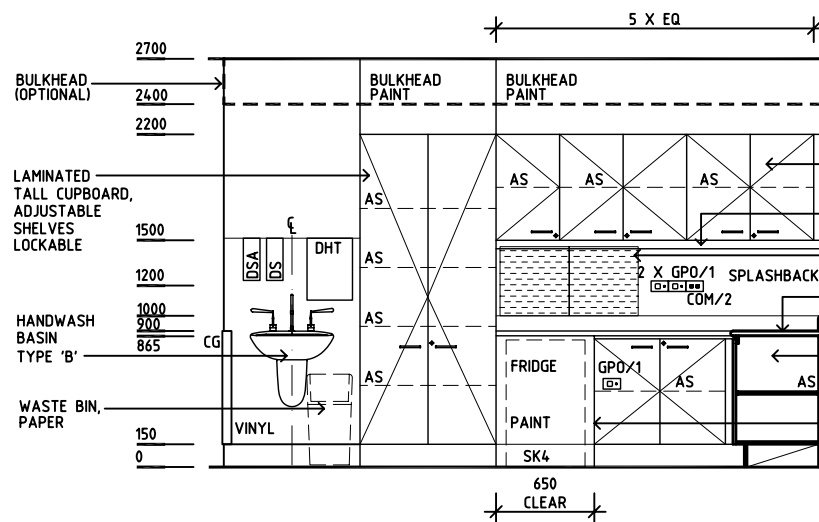

ELEVATION 1

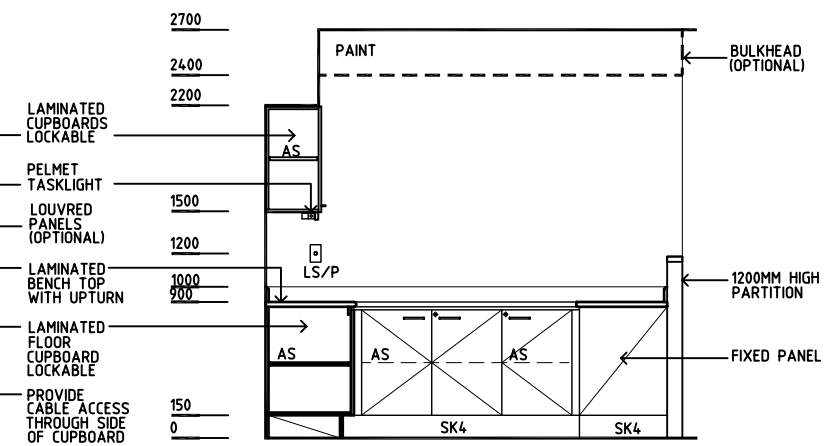

ELEVATION 2

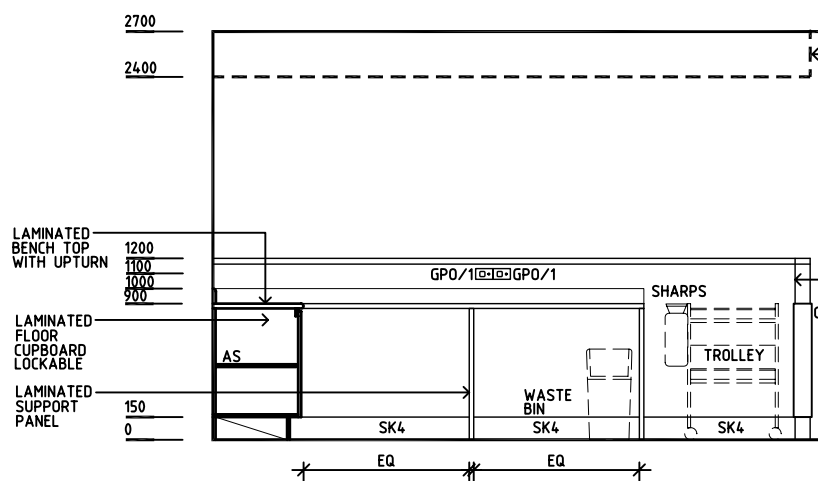

ELEVATION 3

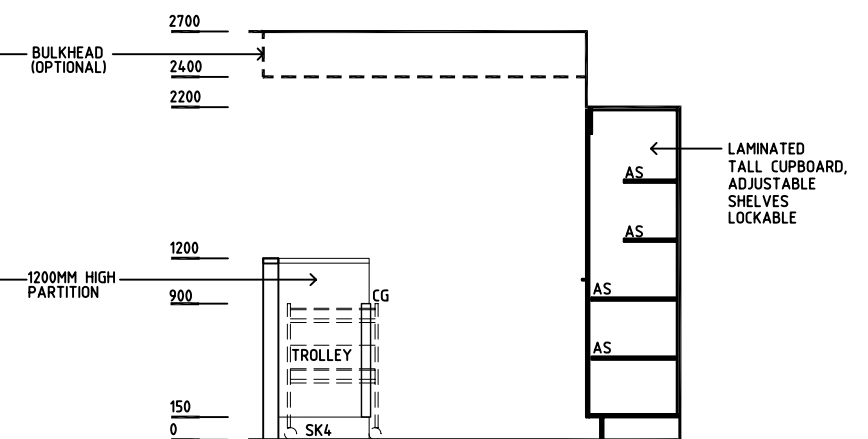

ELEVATION 4

REV	DESCRIPTION	DATE	BY	REV	DESCRIPTION	DATE	BY	REV	DESCRIPTION	DATE	BY
1	FIRST ISSUE	24.10.10	CC								
2	GENERAL REVISION	30.08.11	SK								
3	GENERAL REVISION	31.10.12	CT								

iHFG International Health Facility Guidelines		DESIGNED	APPROVED	DATE	SCALE(S)	SHEET
		CC	DB	24.10.10	1:50 in A3	1 of 2
		CAD FILE NAME		PAPER DRAWING ID		ISSUE
		BLDCW-I		BLDCW-Ia		3

iHFG Standard Components

Room Layout Sheet

Room Name **Blood Collection Work Area**

RLS Room Code **BLDCW-I**

RDS Room Code **BLDCW-I**

GENERAL NOTES:



THIS DRAWING TO BE READ IN CONJUNCTION WITH R.D.S. (ROOM DATA SHEETS) WHICH TAKES PRECEDENCE.

ALL SERVICES INDICATED ARE INDICATIVE AND SUBJECTED TO DETAILED PROJECT SPECIFIC ENGINEERING DESIGN.

CEILING LEGEND:

PB	PLASTERBOARD FLUSH SET CEILING, PAINT
PBB	PLASTERBOARD BULKHEAD, PAINT
PC4	24mm. SHADOW ANGLE, POWDERCOAT ALUMINIUM CORNICE
- - - -	GRID LINE
PB	CEILING TYPE
2700	HEIGHT ABOVE F.F.L.

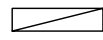
ELECTRICAL LEGEND:

	FLUORESCENT DIFFUSED - RECESSED
	FLUORESCENT DOWNLIGHT - COMPACT

MECHANICAL LEGEND:

	SUPPLY AIR GRILLE
---	-------------------

FIRE SERVICES LEGEND:

	SMOKE DETECTOR
	SPRINKLER

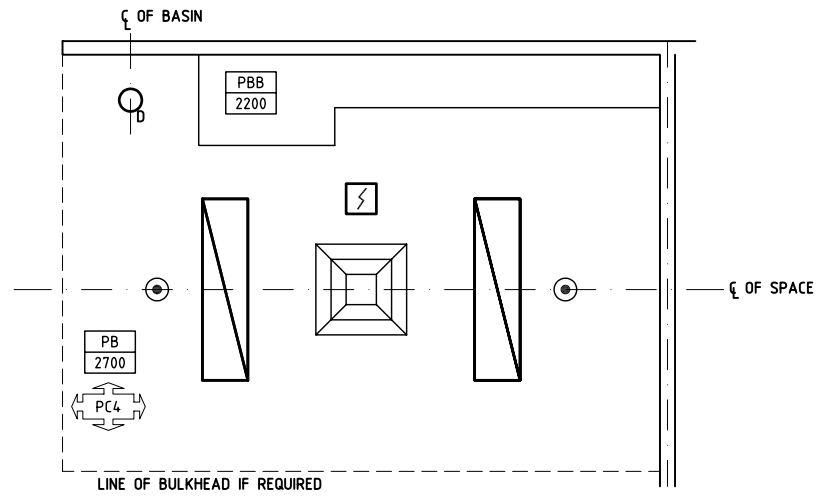

REFLECTED CEILING PLAN

REV	DESCRIPTION	DATE	BY	REV	DESCRIPTION	DATE	BY	REV	DESCRIPTION	DATE	BY
2	GENERAL REVISION	30.08.11	SK								
3	GENERAL REVISION	31.10.12	CT								

 International Health Facility Guidelines	International Health Facility Guidelines at: www.healthdesign.com.au/iHFG Editable version of Standard Components on Health Facility Briefing System (HFBS) at: www.healthdesign.com.au ©TAHPI				DESIGNED	APPROVED	DATE	SCALE(S)	SHEET
	CC	DB	24.10.10	1:50 in A3	2 of 2				
	CAD FILE NAME		PAPER DRAWING ID		ISSUE				
BLDCW-I		BLDCW-Ib		3					



The International Health Facility Guidelines recommends the use of HFBS “Health Facility Briefing System” to edit all room data sheet information for your project.

HFBS provides edit access to all iHFG standard rooms, and departments, and more than 100 custom report templates.

HFBS Health Facility Briefing System



Briefing Module

The Health Facility Briefing System (HFBS) has numerous modules available via annual subscription. It suits healthcare Architects, Medical Planners, Equipment Planners Project Managers and Health Authorities.

Use the HFBS Briefing Module to quickly drag in health facility departments or pre-configured room templates from the iHFG standard, edit the room features such as finishes, furniture, fittings, fixtures, medical equipment, engineering services. The system can print or download as PDF more than 100 custom reports including room data sheets, schedules, and more...

To learn more about the HFBS web-based Healthcare Briefing and Design Software and to obtain editable versions of the “Standard Components” including Room Data Sheets (RDS) and Room Layout Sheets (RLS) offered on the iHFG website, signup for HFBS using the link below.

Get Started Now:
hfbs.healthdesign.com.au

- ✓ iHFG Room Data Sheets and Departments are instantly editable in the HFBS software available online.
- ✓ You can access hundreds of report templates to print your iHFG room data in HFBS.
- ✓ HFBS has a onetime free 3 day trial available to all new users.

Get Started Now:
hfbs.healthdesign.com.au



HFBS

Health Facility Briefing System

hfbsinfo.com | techsupport@healthdesign.com.au